

# N10-4MS

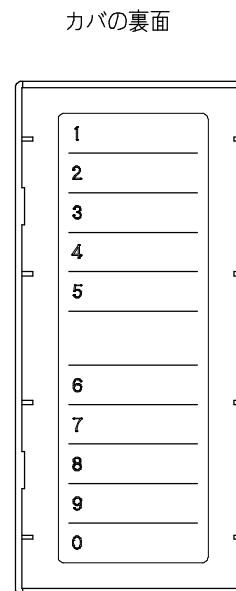

## 内部接続

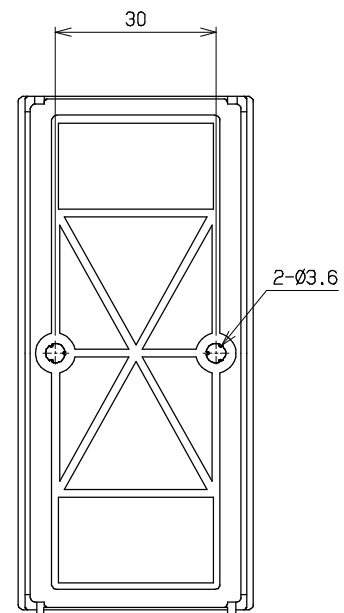
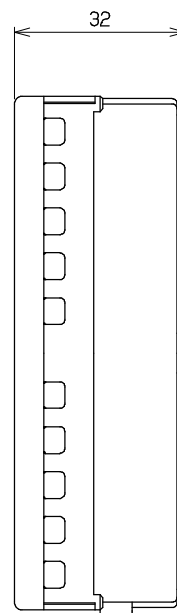
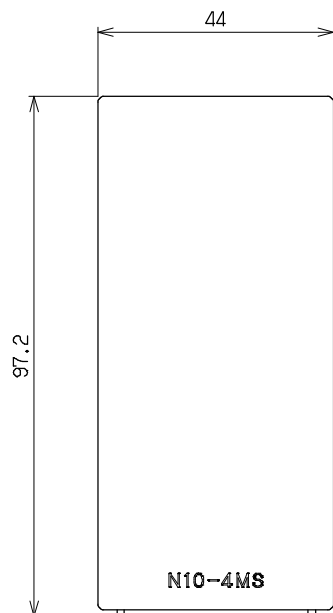
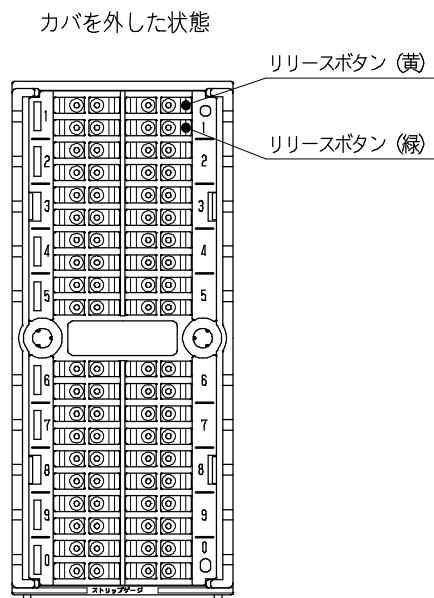
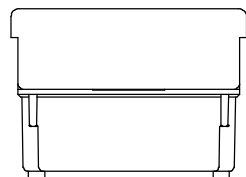
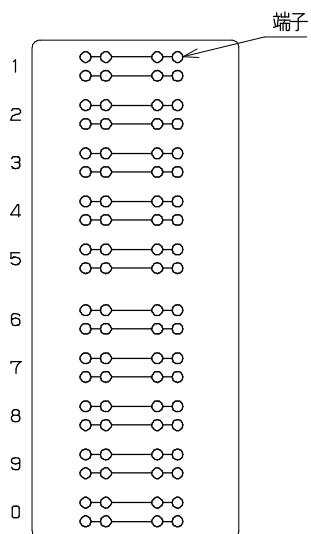

添付ねじ (丸木ねじ3.1×20)

